

ROTEL *hi fi*

AM / FM STEREO RECEIVER

RX-940AX

owner's manual

WARNING
TO PREVENT FIRE OR SHOCK HAZARD,
DO NOT EXPOSE THIS APPLIANCE TO
RAIN OR MOISTURE.

Write your SERIAL NUMBER here.
The number is located near the name
plate on the rear panel.

SAFETY INSTRUCTION

1. **Read Instructions**— All the safety and operating instructions should be read before the appliance is operated.
2. **Retain Instructions**— The safety and operating instructions should be retained for future reference.
3. **Heed Warnings**—All warnings on the appliance and in the operating instructions should be adhered to.
4. **Follow Instructions**— All operating and use instructions should be followed.
5. **Water and Moisture**— The appliance should not be used near water — for example, near a bathtub, washbowl kitchen sink, laundry tub, in a wet basement, or near a swimming pool, and the like.
6. **Carts and Stands**—the appliance should be used only with a cart or stand that is recommended by the manufacturer.
- 6A. An appliance and cart combination should be moved with care. Quick stops, excessive force, and uneven surfaces may cause the appliance and cart combination to overturn.
7. **Wall or Ceiling Mounting**— The appliance should be mounted to a wall or ceiling only as recommended by the manufacturer.
8. **Ventilation**—The appliance should be situated so that its location or position does not interfere with its proper ventilation. For example, the appliance should not be situated on a bed, sofa, rug, or similar surface that may block the ventilation openings; or placed in a built-in installation such as a bookcase or cabinet that may impede the flow of air through the ventilation openings.
9. **Heat**— The appliance should be situated away from heat sources such as radiators, heat registers, stoves, or other appliances (including amplifiers) that produce heat.
10. **Power Sources**— The appliance should be connected to a power supply only of the type described in the operating instructions or as marked on the appliance.
11. **Grounding or Polarization**— The precautions that should be taken so that the grounding or polarization means of an appliance is not defeated.
12. **Power-Cord Protection**— Power-supply cords should be routed so that they are not likely to be walked on or pinched by items placed upon or against them, paying particular attention to cords at plugs, convenience receptacles, and the point where they exit from the appliance.

PORTABLE CART WARNING



S3125A

13. **Cleaning**— The appliance should be cleaned only as recommended by the manufacturer.
14. **Nonuse Periods**— The power cord of the appliance should be unplugged from the outlet when left unused for a long period of time.
15. **Object and Liquid Entry**— Care should be taken so that objects do not fall and liquids are not spilled into the enclosure through openings.
16. **Damage Requiring Service**— The appliance should be serviced by qualified factory authorized service personnel when:
 - A. The power-supply cord or the plug has been damaged; or
 - B. Objects have fallen, or liquid has been spilled into the appliance; or
 - C. The appliance has been exposed to rain; or
 - D. The appliance does not appear to operate normally or exhibits a marked change in performance; or
 - E. The appliance has been dropped, or the enclosure damaged.
17. **Servicing**— The user should not attempt to service the appliance beyond that described in the operating instructions. All other servicing should be referred to qualified factory authorized service personnel.

WARNING: To reduce the risk of fire or electric shock, do not expose this appliance to rain or moisture



CAUTION
RISK OF ELECTRIC SHOCK
DO NOT OPEN



CAUTION: TO REDUCE THE RISK OF ELECTRIC SHOCK, DO NOT REMOVE COVER (OR BACK). NO USER-SERVICEABLE PARTS INSIDE. REFER SERVICING TO QUALIFIED SERVICE PERSONNEL.

The lightning flash with arrowhead symbol, within an equilateral triangle, is intended to alert the user to the presence of uninsulated "dangerous voltage" within the product's enclosure that may be of sufficient magnitude to constitute a risk of electric shock to persons.



The exclamation point within an equilateral triangle is intended to alert the user to the presence of important operating and maintenance (servicing) instructions in the literature accompanying the appliance.



Power Lines — An outdoor antenna should be located away from power lines.

Outdoor Antenna Grounding — If an outside antenna is connected to the receiver, be sure the antenna system is grounded so as to provide some protection against voltage surges and built up static charges. Section 810 of the National Electrical Code, ANSI / NFPA No. 70-1984, provides information with respect to proper grounding of the mast and supporting structure, grounding of the lead-in wire to an antenna discharge unit, size of grounding conductors, location of antenna-discharge unit, connection to grounding electrodes, and requirements for the grounding electrode. See Figure.

- a— Use No. 10 AWG (5.3 mm²) copper, No. 8 AWG (8.4 mm²) aluminum, No. 17 AWG (1.0 mm²) copper-clad steel or bronze wire, or larger, as a ground wire.
- b— Secure antenna lead-in and ground wires to house with stand-off insulators spaced from 4-6 feet (1.22 - 1.83 m) apart.
- c— Mount antenna discharge unit as close as possible to where lead-in enters house.
- d— Use jumper wire not smaller than No. 6 AWG (13.3 mm²) copper, or the equivalent, when a separate antenna-grounding electrode is used.

EXAMPLE OF ANTENNA GROUNDING AS PER NATIONAL ELECTRICAL CODE INSTRUCTIONS

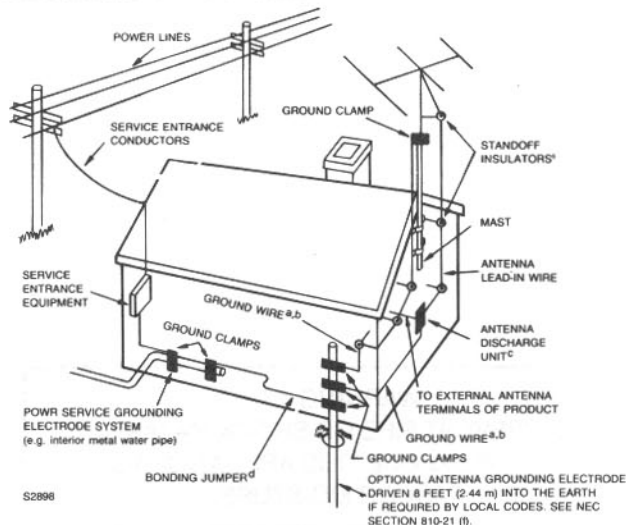

FOR U.S.A. ONLY

ENGLISH

AM/FM STEREO RECEIVER RX-940AX

A WORD FROM ROTEL

Rotel take this opportunity to thank you for choosing our equipment for your home entertainment.

Rotel equipment represents a very high state of the art in sound reproduction, as the result of our everlasting determination to achieve the truly hi-fi performance. Please enjoy the sound Rotel have created for many years to come.

To make sure you get the most out of your equipment, please read this owner's manual carefully before you attempt any connections.

BEFORE CONNECTIONS

1. Place for Installation

Ensure to place the unit in a flat surface where it is free from humidity, vibration, high temperature and not exposed to direct sunlight. Also, be careful not to place the unit in a highly enclosed area without adequate ventilation around the unit. Do not block the ventilation openings at the top and the bottom of the unit to prevent excessive heat built up.

2. Electrical Requirements

Your equipment has been designed to be powered by the local AC voltage. Check the setting of your unit by looking at the rear panel name plate. Never try to plug the unit into an outlet of higher voltage, as this causes a serious fire hazard. Consult your dealer if in doubt.

3. Connecting the Power Cord

Always handle the power cord with care. Ensure to connect the cord to the household wall outlet. When plugging and unplugging make sure the power switch on the unit is turned off.

4. Do not Open the Cabinet

There are no user-serviceable parts inside the cabinet of the unit. Do not attempt to open the cabinet or tamper with

EXCLUSIVE NOTE FOR U.K.

If your unit comes with a 2-core mains lead without a plug, neither core is to be connected to the earth terminal of a three pin plug, make certain that they are connected, according to the following instruction, to the proper terminals. Check that the terminals are screwed down firmly and no loose strands of wire are present.

IMPORTANT: The wires in this mains lead are coloured in accordance with the following code:

BLUE: NEUTRAL

BROWN: LIVE

As the colours of the wires in the mains lead of this apparatus may not correspond with the coloured markings identifying the terminals in your plug proceed as follows:

The wire which is coloured BLUE must be connected to the terminal which is marked with the letter N or coloured BLUE or BLACK. The wire which is coloured BROWN must be connected to the terminal which is marked with the letter L or coloured BROWN or RED.

the internal components. If water or foreign object falls inside the unit by accident, disconnect the power cord immediately and consult a qualified electrician or your dealer.

5. Cleaning Your Unit

If your unit becomes dirty, wipe it gently with a soft, dry cloth. Never use solvents of any kind.

CONNECTIONS

1. Installing and Connecting Antenna

a) Indoor FM Antenna – The attached indoor antenna wire will suffice for proper, quiet broadcast reception in most good reception areas. To install it, connect the antenna to the FM Antenna terminals (75 ohm) on the back of the tuner. Then, stretch the wire out and secure along a wall or where reception is optimal.

- Indoor T-shap Antenna wire (Applicable for U.S.A., Canada or where approved to the usage)

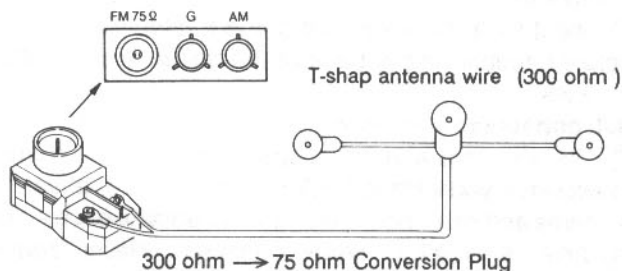

- Indoor Antenna wire (Applicable for European version)

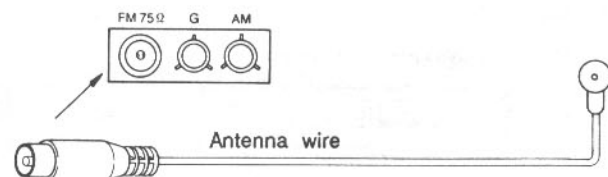

b) Outdoor FM Antenna – In areas of average to weak reception conditions, an outdoor antenna mounted on the roof or top of the building may be necessary for best results. When using such outdoor type antenna, ensure remove the indoor antenna. A 75 -ohm coaxial cable is usually recommended, if using this type cable, properly hook it up to the designated antenna terminals on the back of the tuner.

When in doubt on the FM outdoor antenna system, consult your dealer.

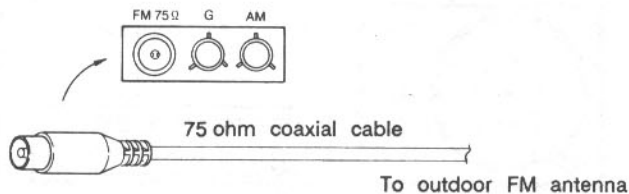

c) **AM Antenna** – The loop antenna is provided for AM reception. Lock the loop onto the loop holder on the back of the tuner, and connect the two ends to the antenna terminals marked G and AM. Swing out the loop around for finding the best AM reception. In difficult reception areas, connect an outdoor antenna which is usually a long piece of shielded wire to the AM terminal. Make sure the loop is still connected even if the outdoor or another antenna is used.

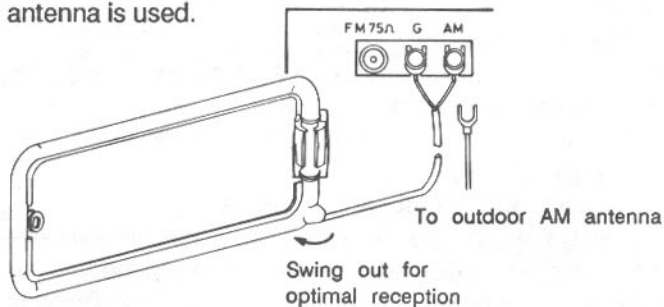

2. Connecting components

The illustration shows what audio components you can connect to the rear panel of the unit and how they should be properly hooked up via RCA type pin cords. Ensure that the Left and the Right channels are correctly matched between the RCA type sockets of the unit and those on the components.

Connect the grounding wire of the turntable to the GND screw terminal on the back of the unit near the PHONO sockets.

3. Connecting Speakers

a) Use speakers with impedance ratings of 4 to 8 ohms. However, if you wish to hook up 2 sets (pairs) of speaker systems and drive both sets simultaneously, ensure each speaker is rated 8 ohms minimum. Never connect speakers with lower impedance than 8 ohms in this case. The speaker impedance is indicated on the back or in the instruction manual of the speaker.

b) Do not use speakers that have very high capacitive load, say over 0.1 microfarads, as it may cause a damage to the power amplifier section. Normally, most speakers are low capacitance type, but there are a few which do have excessively high capacitance.

c) Use proper speaker cords normally your dealer will recommend, with as low capacitance content as possible. The speaker terminal posts provided on the back of the unit can also take banana plugs.

d) If connecting the speaker cords directly with the bare wire ends, suggest you strip about 1 cm of the insulation shield cover from the ends of the speakers cords. Twist any exposed strands tightly, and insert the ends properly to the terminal posts.

e) The DIRECT terminal posts are recommended for the best sound quality possible from the unit in the "straight-path" route bypassing the headphone circuit. The sound from the speakers connected to the DIRECT terminal posts will not be affected by the Speaker Remote button on the front panel. However, if you wish to listen to your headphone privately, connect your speakers to the REMOTE terminal posts and use the speaker Remote button on the front panel to turn the speakers off.

f) The REMOTE terminal posts are for the second pair of speakers if you wish to use it for such as providing sound to another room. The sound from the remote speaker can be turned on and off by the front panel speaker Remote button.

g) Ensure the Left and the Right channels are correctly connected between the unit and the speakers, and make sure for each channels the "+" and the "-" are also correctly matched. Check that the speaker cord ends (exposed tips) on the terminal posts are not stray and touching one another, which will cause short circuits and may damage both the unit and the speakers.

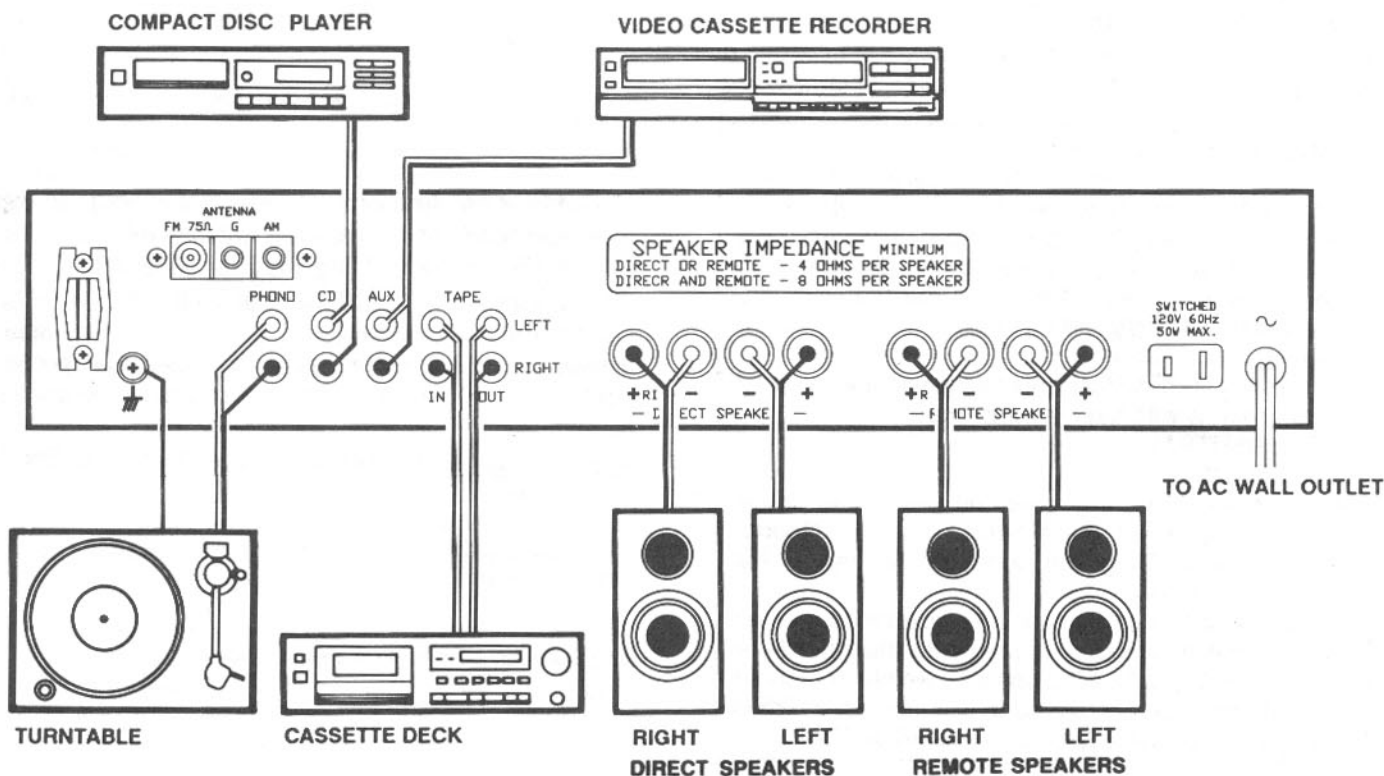

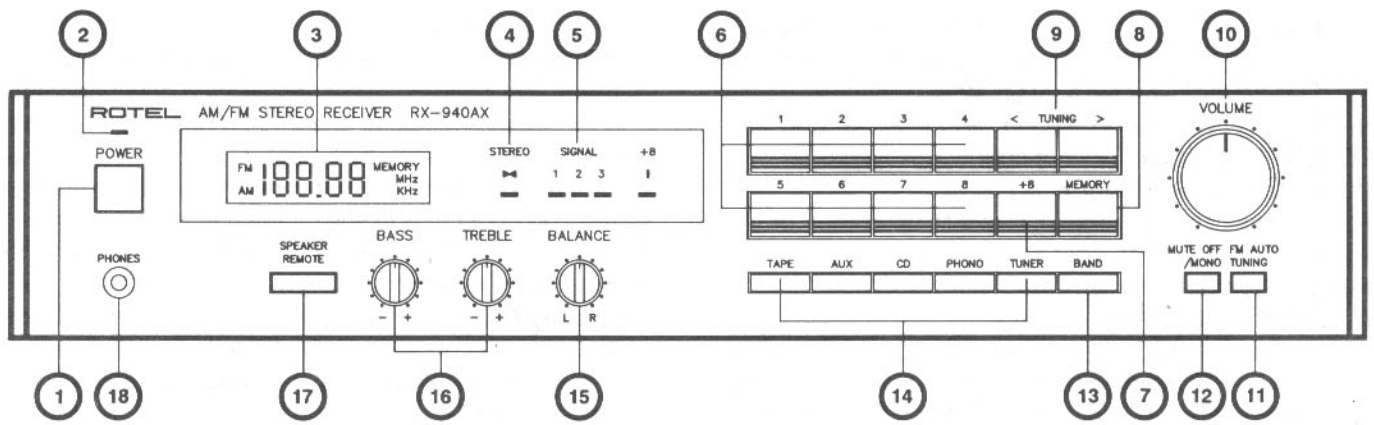

SWITCHES AND CONTROLS

(1) Power Button

Press this button to turn on and off the unit.

(2) Power Indicator

Glow when power is turned on with the power button.

(3) Frequency Display

1) The frequency of the station selected is displayed. The band chosen, FM or AM, is also shown together with MHz for FM or kHz for AM (both MW and LW) on the frequency display.

2) The word MEMORY lights up while the Memory button is activated.

(4) STEREO Indicator

The LED indicator glows when stereo broadcasting station is tuned in and when the Muting Off/ Mono button is deactivated for the stereo operation. It will also not light up for very weak stereo signals which the tuner will not receive in stereo.

(5) Signal Indicator

The 3-LED indicator lights up to show the incoming signal strength (sensitivity). Receiving condition for a broadcast is optimized when all 3 LED's or as many LED's illuminated.

(6) Stations Button

Pressing one of these buttons will tune the tuner to the frequency stored in the memory. Pressing the Memory button followed by one of these buttons will store up to 16 AM or FM stations in the memory. The LED on each station button will light up when station button pressed.

CAUTION: If the power button is off more than 2 weeks, the frequencies stored in the memories will be lost.

NOTE: Each time you switch the tuner on, it will tune to the station frequency to which it was previously tuned.

(7) +8 Button

The tuner can store up to 16 different frequencies in its memory. The first 8 are selected (or stored) just by pressing the appropriate button. The second 8, numbers 9 to 16, are selected by pressing the +8 button and next to press the desired station button.

The LED indicator on display window light up when the +8 button depressed.

(8) Memory Button

Stores frequencies in the tuner's memory. To store a frequency first tune to the desired broadcast program using the Tuning button. Then press the Memory button followed by one of the station buttons marked 1 to 8 and 9 to 16 with the +8 button. Although there are only 8 buttons marked for positions 1 to 8, the +8 button con-

verts the buttons to positions 9 to 16. So the buttons have double functions, e.g., the button 1 is also 9 when used with the +8 button.

The Memory indicator in the display will light up during this process. Note that once the Memory button is pressed, you must press the required station button within a few seconds to store the station frequency. If the Memory indicator is no longer light, you must press the Memory button again before storing the required frequency.

For example, to store desired local station in the station button 12, first tune in to the station, press the Memory button, then press the +8 button and next to press the station button 4.

(9) Tuning Button

Allows to tune in frequencies. Press the right side button marked > to tune in the higher frequencies and the left side button marked < to tune in the lower frequencies.

(10) Volume Control

Used to regulate the volume level. Turn clockwise to increase the volume level and counterclockwise to reduce it. Due to the high quality material and construction used on the volume control for sound quality, the sound level will not rise sharply at low settings. Normally, the control is recommended to be set between 11:30 to 2:00 o'clock position with other Rotel's equipments connected, but a finite adjustment will depend on the sensitivity of your speakers.

(11) FM Auto Tuning Button

Permits to choose auto or manual tuning. In the auto mode, pressing either the Tuning button will cause the tuner to increase or decrease, depending on which the Tuning button pressed, the received frequency until a reasonably strong signal is received. At this point the tuning will stop automatically.

In the manual mode, pressing either Tuning button causes the tuner to increase or decrease the received frequency only for as long as the Button is depressed.

NOTE: Auto tuning does not operate for AM (Both MW and LW) band.

(12) Mute Off/ Mono Button

Allows selection of FM mono or stereo operation. When the Mono position is chosen, any broadcast will be received monaurally and the muting switch for suppressing interstation noise will be deactivated to pull weak signals which are normally cut off during the stereo operation. For reception of weak and noisy signals, use the Mute Off/ Mono position. For normal use, choose the stereo

operation by deactivating the Button. In this position, stereo broadcasts will be provided in stereo and the STEREO LED indicator will light up. When mono programs are broadcasted, mono sound is provided and the STEREO LED indicator will not light.

(13) Band Selection Button

Allows to select reception on FM or AM band (MW or LW in case of the tuner with both MW and LW).

(14) Function Selector Button

Allows to choose any input source.

TAPE– Use to playback the Cassette Tape Deck connected to TAPE input, and also allows to monitor the connected source (Tuner, Phono, CD, or Aux) when recording.

AUX– When playing the connected VCR, Video Disc Player and or other auxiliary components.

CD– When playing the Compact Disc Player.

PHONO– When playing the connected Turntable.

TUNER– When listening to FM or AM (MW or LW in case of Tuner with both MW and LW) broadcasts.

(15) Balance Control

Set normally at the center position for equal volume level from both speakers. Turning to the right decreases the sound from the left speakers, and turning to the left decreases the sound from the right speakers. Use the control only when there is an unbalance in the sound level between the two speakers.

(16) Tone Controls

The BASS control regulates the low frequencies and the TREBLE control regulates the high frequencies. The center points are for the flat frequency response. Turn clockwise to boost the response and counterclockwise to reduce it, if your listening room acoustics are excessively lively or dead and requires the compensations when adjustments by relocating the speakers, rearranging furnitures, etc. all failed.

(17) Speaker Remote Button

Press the button to activate the speakers connected to the REMOTE speaker terminal posts on the back panel. Release the button to cut off the sound from the Remote speakers.

(18) Phones Jack

Plug your headphones to this jack, making sure it has the correct type connector. For private listening, if your speakers are connected to the DIRECT speaker terminal posts on the back panel, you have to disconnect the speakers off the terminal posts to cut off sound from the speakers; however, if your speakers are connected to the REMOTE speaker terminal posts, deactivate the speaker Remote button to cut off sound from the speakers. Hence, if you are frequent user of the headphones, you may wish to connect the speakers to REMOTE terminal posts all the time.

WORDS ON OPERATIONS

Precautions

1. Before commencing operation, check to see if all connections are properly made.
2. Always ensure to set the Volume control to the minimum position before turning on the Power switch.

Playing Turntable

1. Set to the PHONO position on the Function selector button.
2. Use only a high quality cartridge to obtain the maximum potential from the unit's high quality phono circuit. Usually using cartridges as recommended by your dealers will prevent any grief on the suitable matching.
3. Start playing Turntable, then raise the volume to the desired listening level.

Operating CD Player

1. Set to the CD position on the Function selector button.
2. Read the instruction manual of your player carefully to maximize the full potential.
3. Using higher quality interconnecting cords between your CD player and this receiver may often improve sound quality.
4. Start playing CD, then raise the volume to the desired listening level.

Tuner Reception

1. Set to the TUNER position on the Function selector button and select AM or FM by BAND button.
2. Tune in the desired station, then raise the volume to the desired listening level.

Memory Backup

As explained above, the memory for the preset stations is retained as long as the power cord is plugged into an AC outlet. However, if you leave the power cord unplugged for over 2 weeks, or if there is a power failure for over 2 weeks, the stored frequencies will be lost.

In such cases, the operation for storing frequencies in the memory have to be done again from the beginning.

Tuning Modes

Bear in mind that there are 3 modes of tuning with the tuner : auto tuning, manual tuning, and preset (memory) tuning. The simplest is the pereset tuning, as you only have to stored up to 16 of your favorite FM or AM stations once and recall any one of them with one touch (or two touches in case of the buttons 9 to 16). Make sure to learn the proper method for the storage in the memory as instructed above.

Tape Deck Playback

1. Set to the TAPE position on Function selector button if your tape deck is connected to the TAPE inputs on the back of the unit.
2. Use only a good quality cassette tape deck (in terms of sound quality) or a DAT deck, etc. for maximizing the full potential of the amplifier.
3. Please note you may connect another cassette deck or the audio output of your video tape deck to the AUX inputs on the back of the unit, for a playback purpose only as no output supplied for recording.

Recording Tape Deck

1. If your tape deck is connected to the TAPE outputs on the back of the unit, you can record any input on the Function selector. Set the Function selector to the input you wish to record, and proceed the recording with your tape deck.
2. During recording operation, the volume control and the tone controls have no effect on the recorded signal being fed to the TAPE outputs.

HUM AND NOISE

In any high fidelity installations, hum may be caused by the interconnection of turntable, tuner, amplifier and speakers as the result of wiring, different grounding or locations of components.

Normally, hum is rarely associated with a faulty tuner, and the most likely cause lies in the installation. If any part of the antenna is in contact with a ground point (copper water pipes for example) hum will almost certainly result if your amplifier has a three core mains lead. It is also important to check that the audio interconnect cords have been pushed fully into their sockets on both tuner and amplifier. Sometimes the problem is actually caused by a signal which is too strong, in which case an antenna attenuator is recommended. If in doubt, please consult your dealer.

SPECIFICATIONS RX-940AX

AMPLIFIER SECTION

Continuous Power Output...30 watts* per channel, min.
RMS both channels driven into
8 ohms from 20 to 20,000 Hz
with no more than 0.03 % total
harmonic distortion.

DIN Power Output.....50 watts per channel (1 kHz, 4
ohms, 1 % THD)

Total Harmonic Distortion...No more than 0.03 % (contin-
(20 to 20kHz from AUX) uous rated power output)

Intermodulation Distortion...No more than 0.03 % (contin-
(60 Hz: 7 kHz = 4:1) uous rated power output)

Output: Speaker.....4 ohms minimum

Headphone.....8 - 2,000 ohms

Damping Factor.....180 (20 to 20,000 Hz, 8 ohms)

Input Sensitivity/ Impedance:

PHONO.....2.5 mV/ 47 kohms

CD, AUX, TAPE 1,2.....150 mV/ 20 kohms

Overload Level (THD 0.5% 1 kHz):

PHONO.....200 mV

CD, AUX, TAPE 1,2.....5 V

Frequency Response:

PHONO.....20 to 20,000 Hz +/- 0.3 dB
(RIAA STD)

CD, AUX, TAPE 1,2.....20 to 20,000 Hz +0 dB,- 1 dB

Tone Control:

BASS..... +/- 6.0 dB (100 Hz)

TREBLE..... +/- 6.0 dB (10 kHz)

Signal-to-Noise Ratio (IHF, A network):

PHONO.....80 dB

CD, AUX, TAPE 1,2.....100 dB

FM TUNER SECTION

Usable Sensitivity.....10.8 dBf/ 0.95 uV (75 ohms)

50 dB Quieting Sensitivity:

Mono.....14.8 dBf/ 1.5 uV (75 ohms)

Stereo.....37.2 dBf/ 20 uV (75 ohms)

Signal-to-Noise Ratio (at 65 dBf):

Mono.....80 dB

Stereo.....75 dB

Harmonic Distortion (at 65 dBf):

1 kHz.....0.07% (mono), 0.25% (stereo)

Frequency Response.....30 to 15,000 Hz +/- 1.0 dB

Capture Ratio.....1.0 dB

Alternate Channel Selectivity:

(+/- 400 kHz).....63 dB

Spurious Response Ratio...95 dB

Image Response Ratio.....70 dB

IF Response Ratio.....95 dB

AM Suppression Ratio.....58 dB

Stereo Separation:

100 Hz/1 kHz/10 kHz.....43 dB/ 46 dB/ 38 dB

Subcarrier Product Ratio...60 dB

Antenna Input.....75 ohms unbalanced

AM TUNER SECTION

	MW	LW
Sensitivity.....	350 uV/ m	750 uV/ m
Selectivity.....	35 dB	35 dB
Signal-to-Noise Ratio.....	55 dB	55 dB
Image Response Ratio.....	40 dB	40 dB
IF Response Ratio.....	60 dB	60 dB
Antenna.....	Loop Antenna	

MISCELLANEOUS

Power Requirement.....120 V/ 60 Hz, 220 V/ 50 Hz,
240 V/ 50 Hz (dependinh on
destinations)

Power Consumption.....180 watts

Dimension (overall).....440 (W) x 92 (H) x 340 (D)mm

17-3/8" x 3-5/8" x 13-3/8"

Weight (net).....7.0 kg/ 15.4 lbs

- Specifications and design subject to possible modifica-
tion without notice.

- *Measured pursuant to the Federal Trade Commis-
sion's Trade Regulation Rule or, Power Claims for
Amplifiers (applicable to the U.S.A. only).